

COMPONENT DRAWINGS

TRACK

All tracks are in galvanised finish.* Once installed they should be kept greased, to reduce wear and increase life. Any length of track is obtained by putting sections of track together and fixing a jointing bracket at the joints, and using end clips or closed brackets at each end.

Available lengths

280 - 305: 1.8, 2, 2.5, 3, 4, & 6m

307: 2, 2.5 & 3m

(mm)	280	290	301	301H	305	307
A	27	45	66	66	93	104
B	30	36	55	55	57	73
C	1.2	2	2	3	3	5

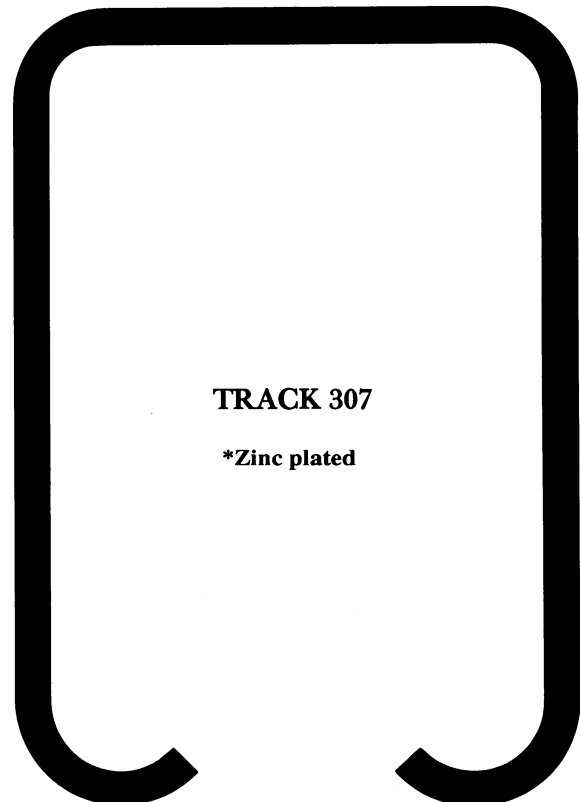
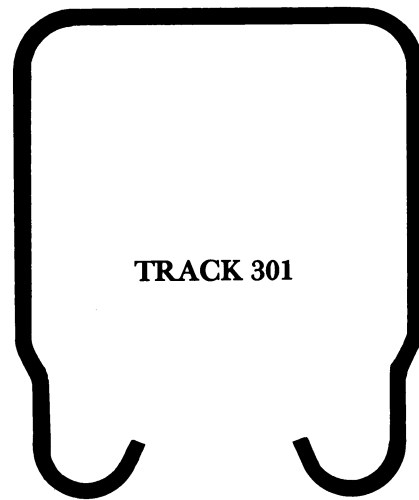
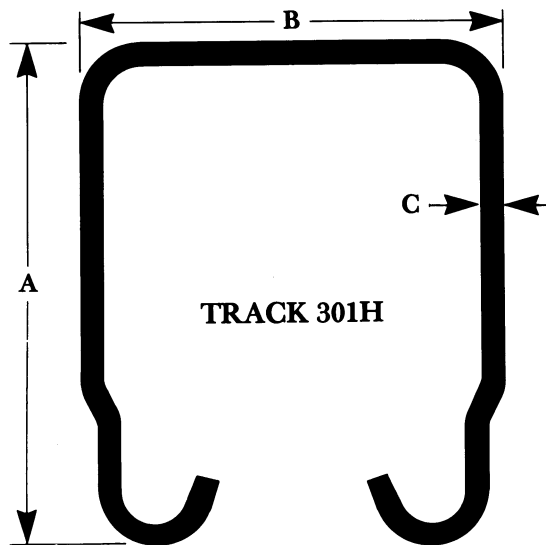
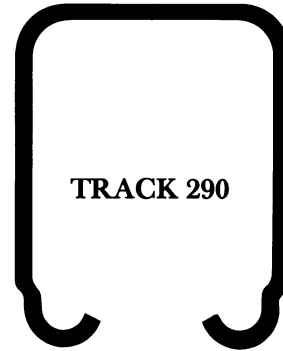

FULL SIZE SECTIONS

COMPONENT DRAWINGS

TRACK BRACKETS

All brackets are aluminium alloy die castings except where indicated with a suffix/S (eg 1/301/S) which are galvanised steel. Fit closed brackets or brackets with end-clip at track ends. Jointing brackets are required at each track joint. Maximum bracket spacing is every 900mm.

BRACKETS - FACE FIXED

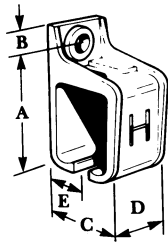

No. 1 or 1A

Cat No.	A	B	C	D	E	Bolt
1A/290	67	13	52	32	27	M8
1/290/S	75	13	55	60	27	M8
1A/301	97	19	73	57	35	M12
1/301/S	95	16	69	60	37	M12
1A/305	140	25	85	76	38	M16
1/307/S	159	24	91	75	45	M16



Bracket End Clips, 1A/290 EC and 1A/301 EC. For converting brackets Nos. 1, 1A, 3A, 4A, 5, 5AA & 6/301 to closed brackets in the 290,301 & 301H formats



New 1/301/S steel bracket is fully compatible with previous design and also accepts the 1A/301 EC End Clips.

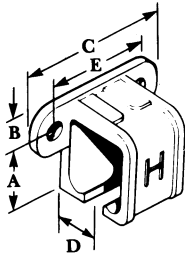

No. 9 or 9A

Cat No.	A	B	C	D	E	Bolt
9A/290	43	16	70	24	51	14C Screw
9/301/S	65	12	125	38	89	18C Screw
9A/305	84	38	160	59	130	M12
9/307/S	84	50	184	69	140	M16

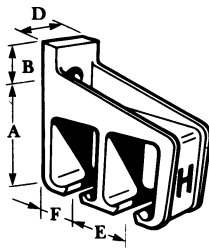

No. 5AA

Cat No.	A	B	D	E	F	Bolt
5AA/301	110	35	57	65	38	M16

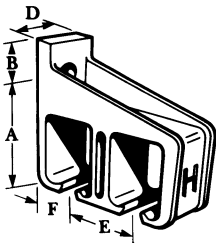

No. 5

Cat No.	A	B	D	E	F	Bolt
5/290	80	20	38	54	27	M12
5/301	110	33	57	79	39	M16
5/305	155	38	75	92	48	M20
5/307/S	192	26	102	91	45	M20

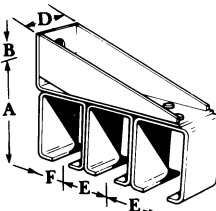

No. 7

Cat No.	A	B	D	E	F	Bolt
7/301/S	116	38	60	66	40	M16

BRACKETS - SOFFIT FIXED

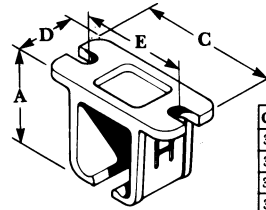

No. 3 or 3A

Cat No.	A	B	C	D	E	Bolt
3A/290	56	-	83	32	64	M8
3A/301	86	-	130	57	100	M12
3/301/S	88	-	130	57	97	M12
3A/305	121	-	168	75	125	M16
3/307/S	158	-	184	90	140	M16

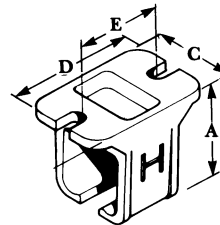

No. 4 or 4A

Cat No.	A	B	C	D	E	Bolt
4A/290	67	-	48	75	60	M8
4A/301	95	-	75	117	95	M12
4A/305	137	-	83	190	130	M16
4/307/S	158	-	91	84	140	M16

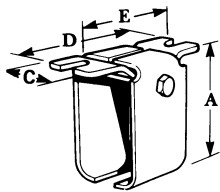

No. 4/301/S

Cat No.	A	B	C	D	E	Bolt
4/301/S	94	-	45	117	95	M12

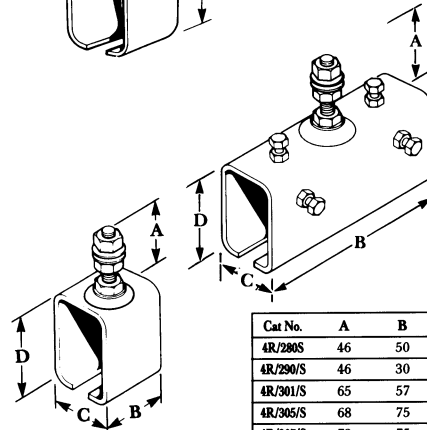

No. 4R

Cat No.	A	B	C	D	Bolt
4R/280S	46	50	35	35	M10
4R/290/S	46	30	44	53	M10
4R/301/S	65	57	65	78	M12
4R/305/S	68	75	71	107	5/8" Whit
4R/307/S	72	75	91	134	M20
4RX/301TS	70	145	64	70	M12

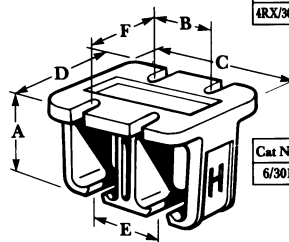

No. 6

Cat No.	A	B & E	C	D	F	Bolt
6/301	95	79	152	127	92	M10

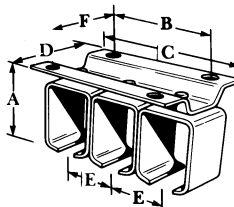

No. 8

Cat No.	A	B	C	D	E	F	Bolt
8/301/S	98	127	178	118	66	92	M12

COMPONENT DRAWINGS

HANGERS

/N = Nylon wheels /S = Steel wheels

Nylon wheels are quieter and avoid the need to grease track to reduce wear. Hence their carrying capacity is greater. For automatic doors halve the carrying capacity and use nylon wheels if possible.

N.B. Door weight capacities are for a pair of hangers.

No.53 WOOD DOORS

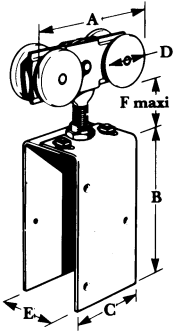

Track No.	Hanger No.	Dimensions						Door weight Capacity
		A	B	C	D	E	F	
290	53K/N	87	95	57	37	35-48	30	150Kg
	53K/S							150Kg
	53K/S 200							200Kg
301	53A/S 53A/N	142	178	76	56	43-57	70	300Kg 400Kg
301H	53A/S 53A/N	142	178	76	56	43-57	71	360Kg 450Kg
305	53C/S	161	178	76	75	43-57	71	700Kg
307	53FJ/S	215	390	65	88	60	94	2000Kg

No.56 METAL DOORS

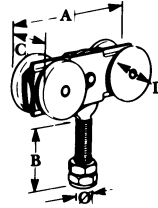

Track No.	Hanger No.	Dimensions					Door weight Capacity
		A	B	C	D	Ø	
290	56K/N	87	32	27	37	10	150Kg
	56K/S						150Kg
	56K/S 200						200Kg
301	56A/S 56A/N	142	70	42	56	16	300Kg 400Kg
301H	56A/S 56A/N	142	70	42	56	16	360Kg 450Kg
305	56C/S	161	70	42	75	16	700Kg
307	56FJ/S	215	86	55	88	20	2000Kg

No.57 WOOD DOORS

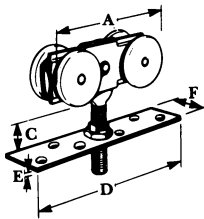

Track No.	Hanger No.	Dimensions					Door weight Capacity
		A	C	D	E	F	
290	57K/N	87	31	140	5	25	150Kg
	57K/S 200						200Kg
301	57A/S	142	57	184	6	38	300Kg
301H	57A/N	142	57	184	6	38	450Kg
305	57C/S	161	61	184	6	38	700Kg

No.56F FIRE DOORS

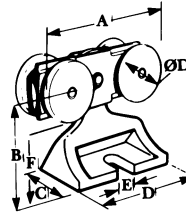

Track No.	Hanger No.	Dimensions							Door weight Capacity
		A	B	C	D	ØD	E	F	
301	56AF/S	142	81	45	83	56	17	53	300Kg
301H	56AF/S	142	81	45	83	56	17	53	360Kg
305	56CF/S	161	89	45	83	75	17	51	700Kg

No.52 WOOD DOORS

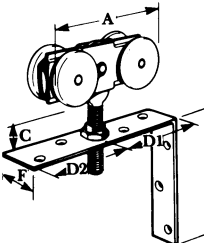

Track No.	Hanger No.	Dimensions						Door weight Capacity
		A	C	D1	D2	E	F	
290	52K/S	87	31	77	51	134	25	150Kg
	52K/N							150Kg
	52K/S 200							200Kg
301	52A/S	142	57	102	127	165	38	300Kg
301H	52A/N	142	57	102	127	165	38	450Kg
305	52C/S	161	61	102	127	165	38	700Kg

No.56X METAL DOORS

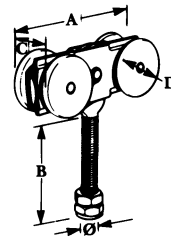

Track No.	Hanger No.	Dimensions					Door weight Capacity
		A	B	C	D	Ø	
290	56KX/S	87	110	27	37	10	150Kg
	56KX/N						200Kg
301	56AX/S 56AX/N	142	146	42	56	16	300Kg 400Kg
301H	56AX/S 56AX/N	142	146	42	56	16	360Kg 450Kg
305	56CX/S	161	146	42	75	16	700Kg
307	56FJX/S	215	140	55	88	20	2000Kg

No.62 FOLDING DOORS

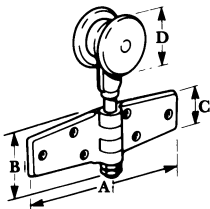

Track No.	Hanger No.	Dimensions			
		A	B	C	D
290	62K	180	77	45	37
301	62A	180	77	45	56
305	62C	540	104	51	75

No.63 FOLDING DOORS

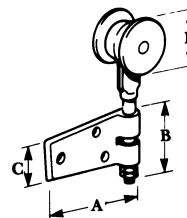

Track No.	Hanger No.	Dimensions			
		A	B	C	D
290	63K	90	77	45	37
301	63A	90	77	45	56
305	63C	203	104	51	75

No.21 FOLDING DOORS

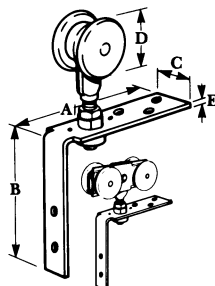

Track No.	Hanger No.	Dimensions				
		A	B	C	D	E
290	21K/S	153	153	25	37	5
	21K/N					
	21K/4N					
301	21A/S	178	153	38	56	6
301H	21A/4S	178	153	38	56	6
305	21C/S	178	153	38	75	6

No.61 FOLDING DOORS

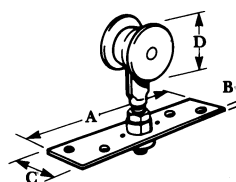

Track No.	Hanger No.	Dimensions			
		A	B	C	D
290	61K/S	140	5	25	37
301	61A/S	184	6	38	56
305	61C/S	184	6	38	75

COMPONENT DRAWINGS

CHANNELS & RAILS

GUIDE CHANNELS

(mm)	89	94	97	100	900	99	13	917	918	297	298	299
A	25	20	38	27	29	38	60	13	10	65	51	51
B	24	21	27	27	45	46	65	35	25	55	51	32
C	3	1.5	3	3	2	3	3	2	2	7	4	3

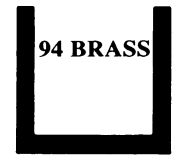
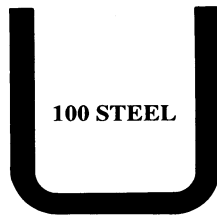
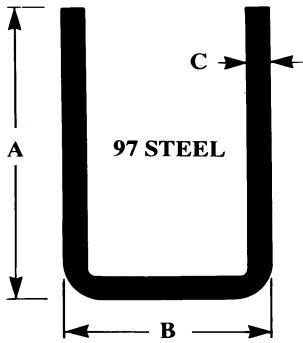

(Aluminium =94X)

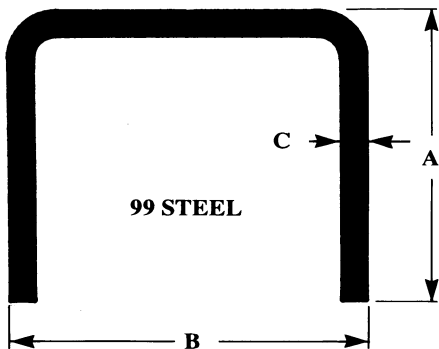
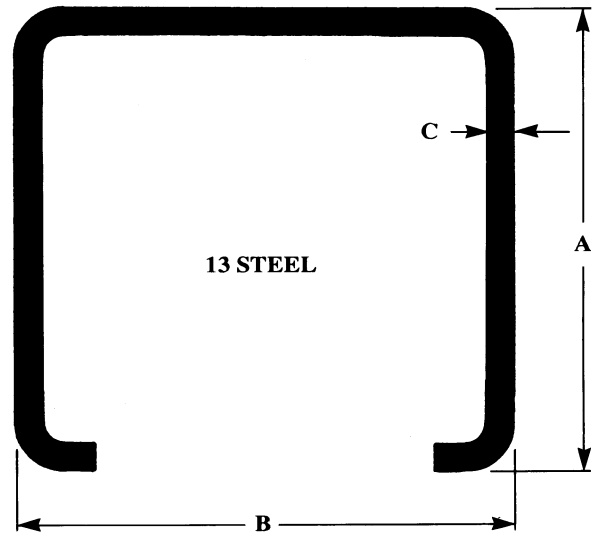
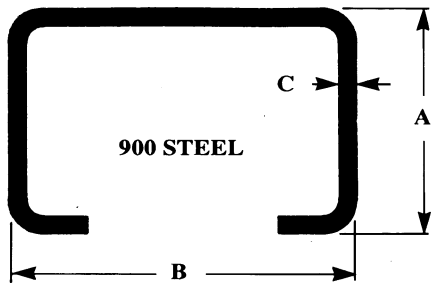

For bracket specifications see Technical Data Sheets.

FULL SIZE SECTIONS

918 BRASS

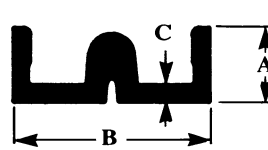

917 BRASS

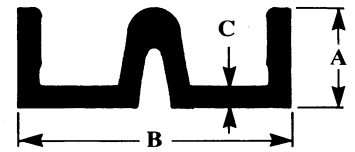

FLOOR RAILS

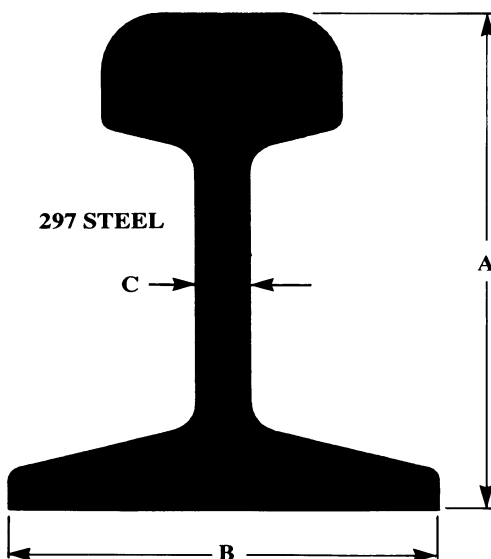

298 STEEL

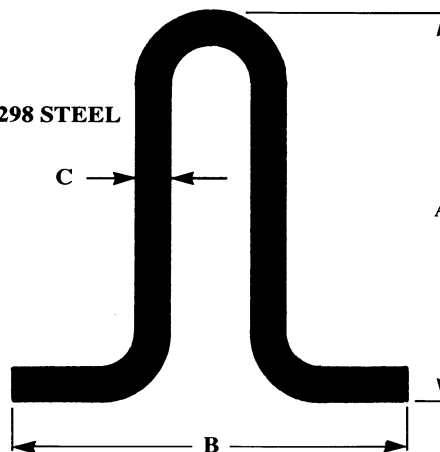

299 STEEL

